

Miniature circuit breakers Din-Safe MCBs (RCBO)

- Standard AS/NZS 61009
- Approval N17482
- Short circuit, overcurrent and earth leakage protection
- Handle sealable and padlockable
- DIN Rail mounting

Din-Safe MCB with pigtail

No of Poles	Amp rating (A)	Voltage (V)	Short circuit (kA)	Phase ¹⁾	Trip Sens. (mA)	Cat. No
2	6	110/240	10	1+N	30	DSRCB0630P
2	10	110/240	10	1+N	30	DSRCB1030P
2	16	110/240	10	1+N	30	DSRCB1630P
2	20	110/240	10	1+N	30	DSRCB2030P
2	25	110/240	10	1+N	30	DSRCB2530P
2	32	110/240	10	1+N	30	DSRCB3230P
2	40	110/240	10	1+N	30	DSRCB4030P

Din-Safe MCB standard terminal configuration

No of Poles	Amp rating (A)	Voltage (V)	Short circuit (kA)	Phase ²⁾	Trip Sens. (mA)	Cat. No ³⁾
2	6	110/240	10	1+N	10	<input type="checkbox"/> DSRCB0610A
2	6	110/240	10	1+N	30	DSRCB0630
2	10	110/240	10	1+N	10	DSRCB1010A
2	10	110/240	10	1+N	30	DSRCB1030
2	10	110/240	10	1+N	100	DSRCB10100
2	16	110/240	10	1+N	10	DSRCB1610A
2	16	110/240	10	1+N	30	DSRCB1630
2	16	110/240	10	1+N	100	DSRCB16100
2	20	110/240	10	1+N	10	DSRCB2010A
2	20	110/240	10	1+N	30	DSRCB2030
2	20	110/240	10	1+N	100	DSRCB20100
2	25	110/240	10	1+N	30	DSRCB2530
2	32	110/240	10	1+N	30	DSRCB3230
2	40	110/240	10	1+N	30	DSRCB4030

Application

Din-Safe MCB is a combined MCB/RCD providing thermal overload, short circuit and earth leakage protection in the one integral unit.

Din-Safe MCBs are suitable for use in residential, commercial and light industrial applications.

Terminal configuration

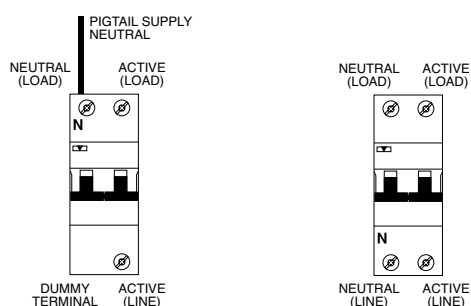

DIN-Safe MCB with neutral pigtail suits standard 3 phase chassis

DIN-Safe MCB standard terminal configuration

Characteristics

- Width: 2 modules.
- For type AC residual currents. ⁴⁾
- Rated voltage: 110/240 V/50-60 Hz.
- Tripping characteristics of MCB part: IEC 60848 - C curve.
- Short circuit capacity: 10 kA.
- Terminal capacity: 25 mm².
- High immunity to transient current.
- Profile as per Din-T MCB.
- Test button for periodic testing.

- Notes:**
- ¹⁾ Unprotected neutral, not switched.
 - ²⁾ Unprotected neutral, switched.
 - ³⁾ Fits Din-T chassis (special configuration) refer page TBA.
 - ⁴⁾ Some type "A" RCDs are stocked. Refer NHP.
- Nuisance tripping may be experienced in VFD and motor starting applications refer NHP.**
- Available on indent only.

Din-T MCBs + RCDs Technical data

Tripping curves according to EN 60898

The following tables show the average tripping curves of the Terasaki Din-T MCBs based on the thermal and magnetic characteristics.

Curve C

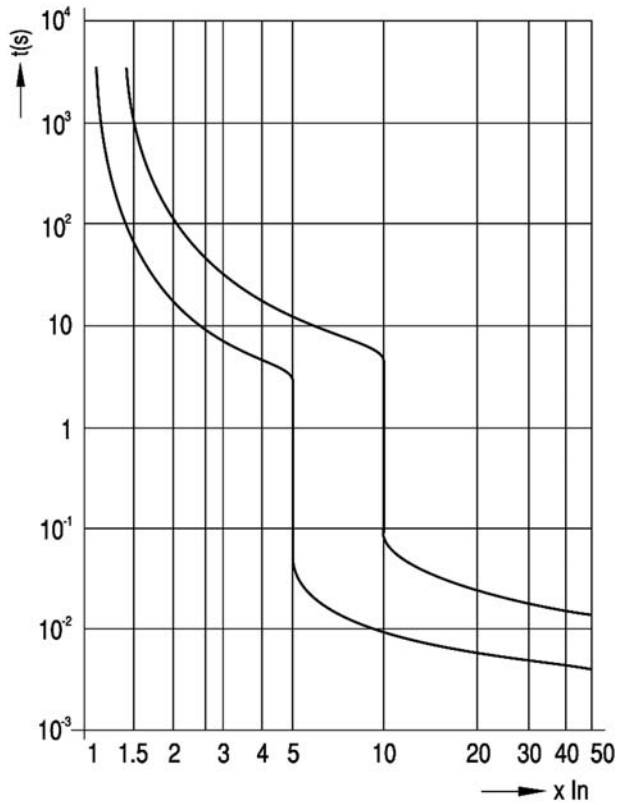

Din-T MCBs + RCDs Technical data

What is an RCD?

3

The RCD (Residual Current Device) is a device intended to protect people against indirect contact, the exposed conductive parts of the installation being connected to an appropriate earth electrode. It may be used to provide protection against fire hazards due to a persistent earth fault current, without operation of the overcurrent protective device.

RCDs having a rated residual operating current not exceeding 30 mA are also used as a means for additional protection in case of failure of the protective means against electric shock (direct contact).

Working Principle

The main components of an RCD are the following:

- The core transformer: which detects the earth fault current.
- The relay: when an earth fault current is detected, the relay reacts by tripping and opening the contacts.
- The mechanism: element to open and close the contacts either manually or automatically.
- The contacts: to open or close the main circuit.

The RCD constantly monitors the vectorial sum of the current passing through all the conductors. In normal conditions the vectorial sum is zero ($I_1+I_2=0$) but in case of an earth fault, the vectorial sum differs from zero ($I_1+I_2=I_d$), this causes the actuation of the relay and therefore the release of the main contacts.

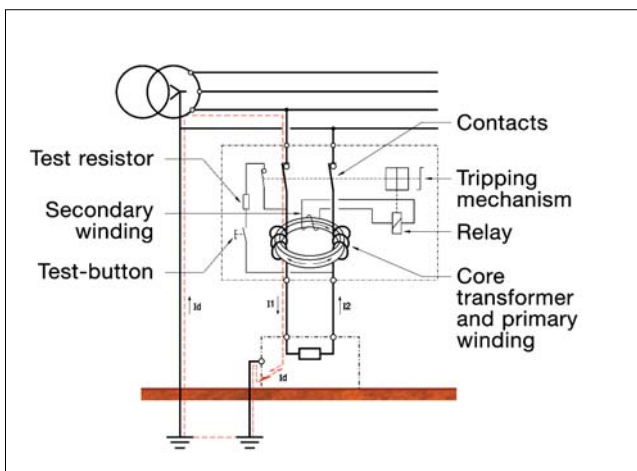

Definitions related to RCDs

RCCB = Residual Current Circuit Breaker without overcurrent protection.

RCBO = Residual Current Circuit Breaker with overcurrent protection.

Breaking capacity

A value of AC component of a prospective current that an RCCB is capable of breaking at a stated voltage under prescribed conditions of use and behaviour.

Residual making and breaking capacity ($I_{\Delta m}$)

A value of the AC component of a residual prospective current which an RCCB can make, carry for its opening time and break under specified conditions of use and behaviour.

Conditional residual short-circuit current ($I_{\Delta c}$)

A value of the AC component of a prospective current which an RCCB protected by a suitable SCPD (short-circuit protective device) in series, can withstand, under specific conditions of use and behaviour.

Conditional short-circuit current (I_{nc})

A value of the AC component of a residual prospective current which an RCCB protected by a suitable SCPD in series, can withstand, under specific conditions of use and behaviour.

Residual short-circuit withstand current

Maximum value of the residual current for which the operation of the RCCB is ensured under specified conditions, and above which the device can undergo irreversible alterations.

Prospective current

The current that would flow in the circuit, if each main current path of the RCCB and the overcurrent protective device (if any) were replaced by a conductor of negligible impedance.

Making capacity

A value of AC component of a prospective current that an RCCB is capable to make at a stated voltage under prescribed conditions of use and behaviour.

Open position

The position in which the predetermined clearance between open contacts in the main circuit of the RCCB is secured.

Closed position

The position in which the predetermined continuity of the main circuit of the RCCB is secured.

Tripping time

The time which elapses between the instant when the residual operating current is suddenly attained and the instant of arc extinction in all poles.

Residual current ($I_{\Delta n}$)

Vector sum of the instantaneous values of the current flowing in the main circuit of the RCCB.

Residual operating current

Value of residual current which causes the RCCB to operate under specified conditions.

Rated short-circuit capacity (I_{cn})

Is the value of the ultimate short-circuit breaking capacity assigned to the circuit breaker. (Only applicable to RCBO)

Conventional non-tripping current (I_{nt})

A specified value of current which the circuit breaker is capable of carrying for a specified time without tripping. (Only applicable to RCBO)

Conventional tripping current (I_t)

A specified value of current which causes the circuit breaker to trip within a specified time. (Only applicable to RCBO)

Din-T MCBs + RCDs Technical data

RCDs classification according to EN 61008/61009

RCDs may be classified according to:

The behaviour in the presence of DC current
(types for general use).

- Type AC
- Type A

The time-delay (in the presence of residual current)

- RCDs without time delay: type for general use
- RCDs with time delay: type S for selectivity

Type AC ^{1) 2)}

The type AC RCDs are designed to release with sinusoidal residual currents which occur suddenly or slowly rise in magnitude.

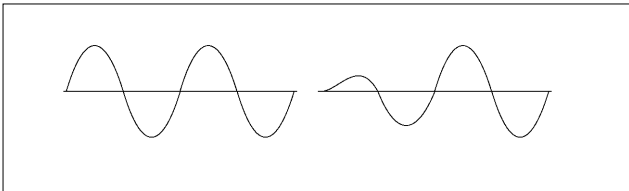

Residual current	Tripping time
0.5 x IΔn	t = ∞
1 x IΔn	t = <300 ms
2 x IΔn	t = <150 ms
5 x IΔn	t = ≤40 ms

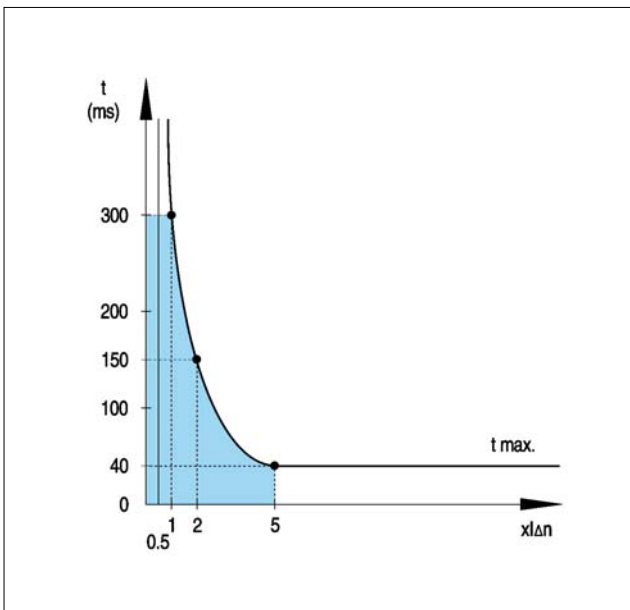

Tripping curve type AC

¹⁾ Standard in Australia
²⁾ Type A acceptable in Australia

Type A ^{3) 4)}

Certain devices during faults can be the source of non-sinusoidal earth leakage currents (DC components) due to the electronic components e.g. diodes, thyristors etc.

Type A RCDs are designed to ensure that under these conditions the residual current devices operate on sinusoidal residual current and also with pulsating direct current(*) which occur suddenly or slowly rise in magnitude.

(*) Pulsating direct current: current of pulsating wave form which assumes, in each period of the rated power frequency, the value 0 or a value not exceeding 0.006 A DC during one single interval of time, expressed in angular measure of at least 150°.

Residual current	Tripping time
1. For sinusoidal residual current	
0.5 x IΔn	t = ∞
1 x IΔn	t = <300 ms
2 x IΔn	t = <150 ms
5 x IΔn	t = ≤40 ms

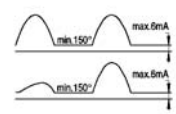
2. For residual pulsating direct current		
At point of wave 0°		
	0.35 x IΔn	t = ∞
	1.4 x IΔn	t = <300 ms
	2.8 x IΔn	t = <150 ms
	7 x IΔn	t = ≤40 ms

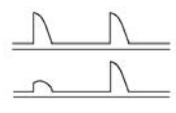
At point of wave 90°		
	0.25 x IΔn	t = ∞
	1.4 x IΔn	t = <300 ms
	2.8 x IΔn	t = <150 ms
	7 x IΔn	t = ≤40 ms

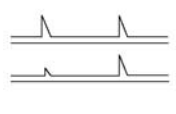
At point of wave 135°		
	0.11 x IΔn	t = ∞
	1.4 x IΔn	t = <300 ms
	2.8 x IΔn	t = <150 ms
	7 x IΔn	t = ≤40 ms

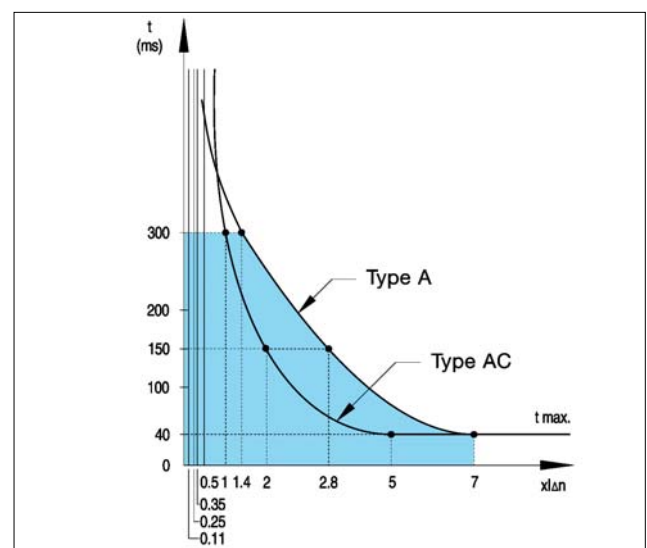

Tripping curve type A
³⁾ Standard in New Zealand
⁴⁾ DSRCBH is type A.

Din-T MCBs + RCDs Technical data

Nuisance tripping

All DinSafe RCDs have a high level of immunity to transient currents, against current impulses of 8/20 μ s according to EN 61008/61009 and VDE 0664.T1.

Type A, AC.....250 A 8/20 μ s

Type S.....3000 A 8/20 μ s

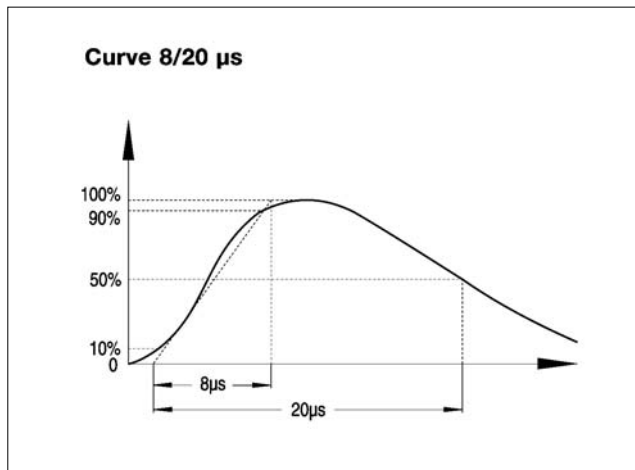

RCDs have a high level of immunity against alternating currents of high frequency according to EN 61008/61009.

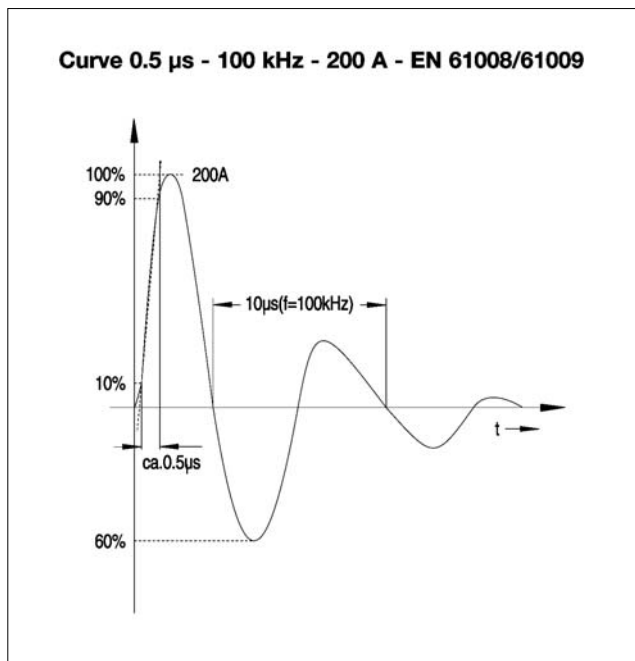

Din-T MCBs + RCDs Technical data

Use of an RCBO Din-Safe (DSRCB)

3

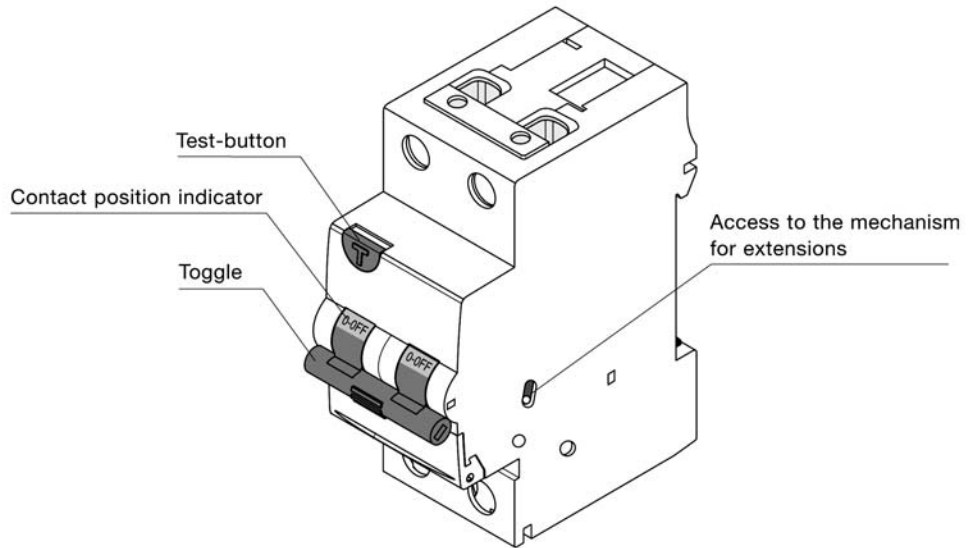

TEST-BUTTON

To ensure the correct functioning of the RCBO, the test button T shall be pressed frequently. The device must trip when the test button is pressed.

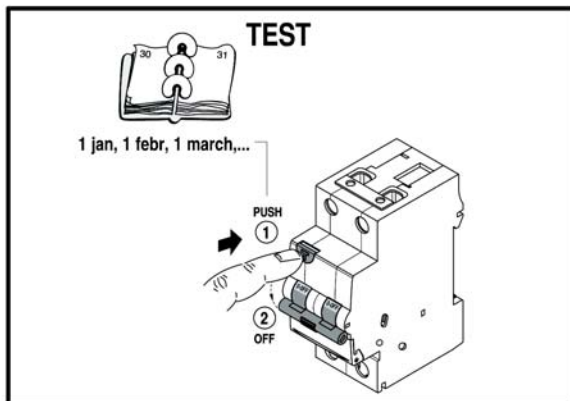

ACCESS TO THE MECHANISM FOR EXTENSIONS

It is possible to add an auxiliary contact, shunt trip, undervoltage release or motor operator, following the stack-on configuration of the extensions in section 4.

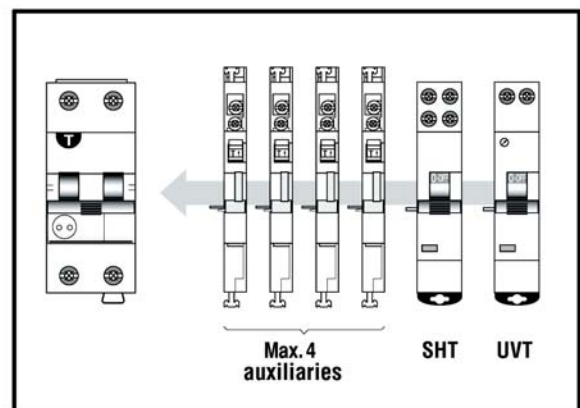

CONTACT POSITION INDICATOR

Printing on the toggle to provide information of the real contact position.

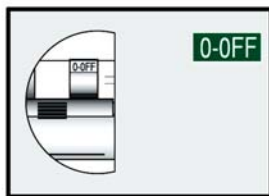

O-OFF
Contacts in open position. Ensure a distance between contacts > 4 mm.

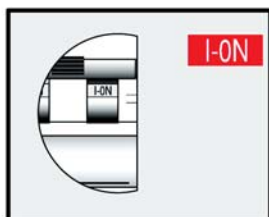

I-ON
Contacts in closed position. Ensure continuity in the main circuit.

ALL CABLES MUST BE CONNECTED TO THE RCBO

All conductors, phase and neutral, that constitute the power supply of the installation to be protected, must be connected to the RCBO to either upper or lower terminals according to the following diagram.

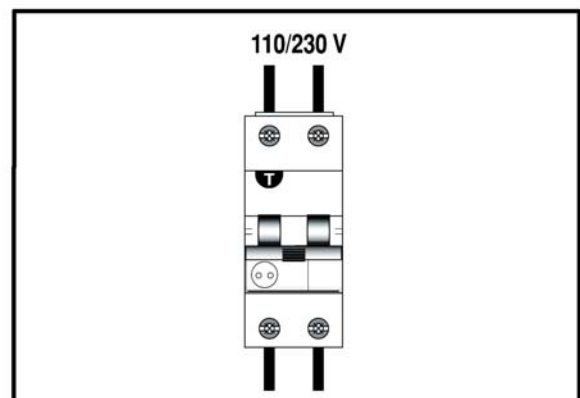

TOGGLE

To manually switch the RCBO ON or OFF

Din-T MCBs + RCDs Technical data

Product related information

Influence of air ambient temperature on the rated current

Influence of temperature on RCBOs (DinSafe DSRCB)

The thermal calibration of the RCBO was carried out at an ambient temperature of 30 °C. Ambient temperatures different from 30 °C influence the bimetal and this results in earlier or later thermal tripping.

3

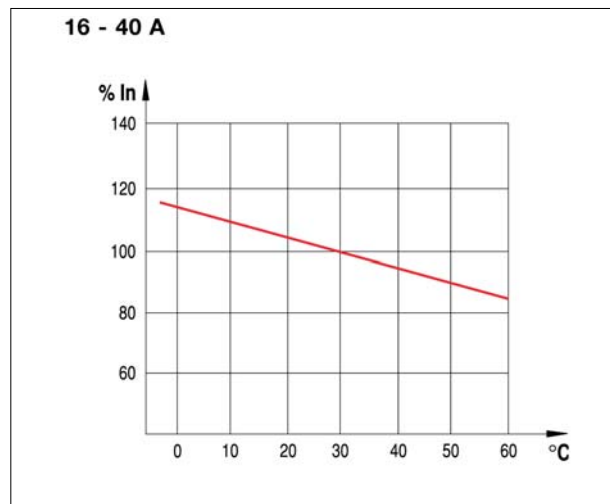
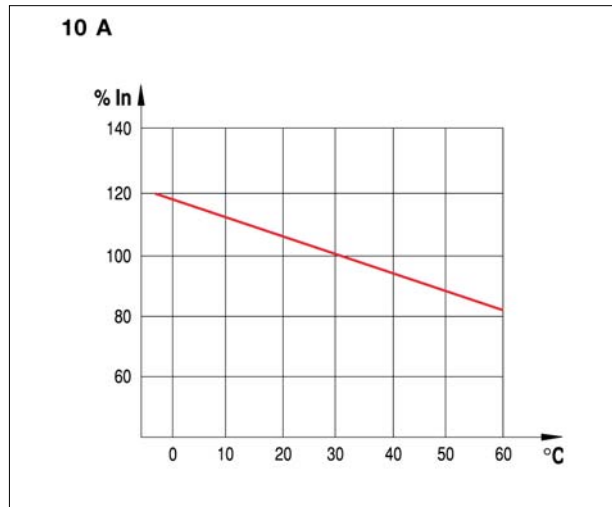
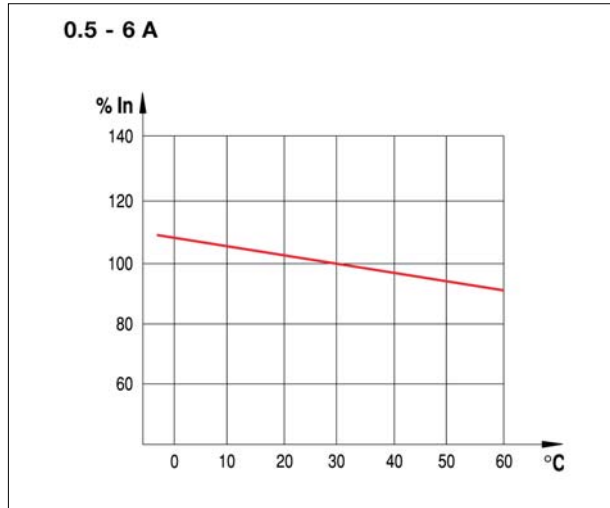

Din-T MCBs + RCDs Technical data

Tripping current as a function of the frequency

All RCDs are designed to work at frequencies of 50-60 Hz, therefore to work at different values, we must consider the variation of the tripping sensitivity according to the tables below. It should be taken into consideration that there is a no tripping risk when pushing the test-button, due to the fact that such action is made by means of an internal resistor with a fixed value.

RCBO DSRCB ³⁾

Type AC ¹⁾	10 Hz	30 Hz	50 Hz	100 Hz	200 Hz	300 Hz	400 Hz
30 mA	0.62	0.65	0.80	0.91	1.24	1.55	1.88
100 mA	0.74	0.71	0.80	0.95	1.16	1.38	1.59
300 mA	0.80	0.74	0.80	0.97	1.19	1.44	1.64
500 mA	1.10	0.81	0.80	0.89	1.18	1.38	1.68
Type A ²⁾							
30 mA	8.17	3.13	0.75	1.70	3.10	3.52	3.67
100 mA	6.81	2.71	0.75	1.43	2.35	2.58	2.71
300 mA	6.20	2.16	0.75	0.49	0.87	0.74	0.95
500 mA	4.34	1.53	0.75	0.39	0.59	0.62	0.64

Notes: ¹⁾ The standard NHP/Terasaki type is the "type AC" in Australia, Type "A" in New Zealand.

²⁾ The standard NHP/Terasaki DSRCBH single pole RCBO is "type A" in Australia and New Zealand.

³⁾ The numbers in the table above are multipliers, e.g. A "DSRCD" at 50 hz has an 0.8 multiplier.
Therefore a 30 mA, "type AC" RCD will trip at (0.8 x 30 mA) 24 mA.

Power losses

The power losses are calculated by means of measuring the voltage drop between the incoming and the outgoing terminal of the device at rated current. Power loss per pole:

RCBO-DinSafe MCB DSRCB

In (A)	4	6	10	13	16	20	25	32	40
Z (mOhm)	125	53	16.5	11.9	9.8	7.1	5.6	4.7	3.6
Pw (W)	2.0	1.9	1.6	2.0	2.5	2.8	3.5	4.8	5.8

Din-T MCBs + RCDs Technical data

RCBO (DSRCB) let-through energy I^2t

The benefit of an RCBO in short-circuit conditions, is its ability to reduce the value of the let-through energy that the short-circuit would be generating.

Din-Safe DSRCB

Curve C

Let-through energy at 230 V

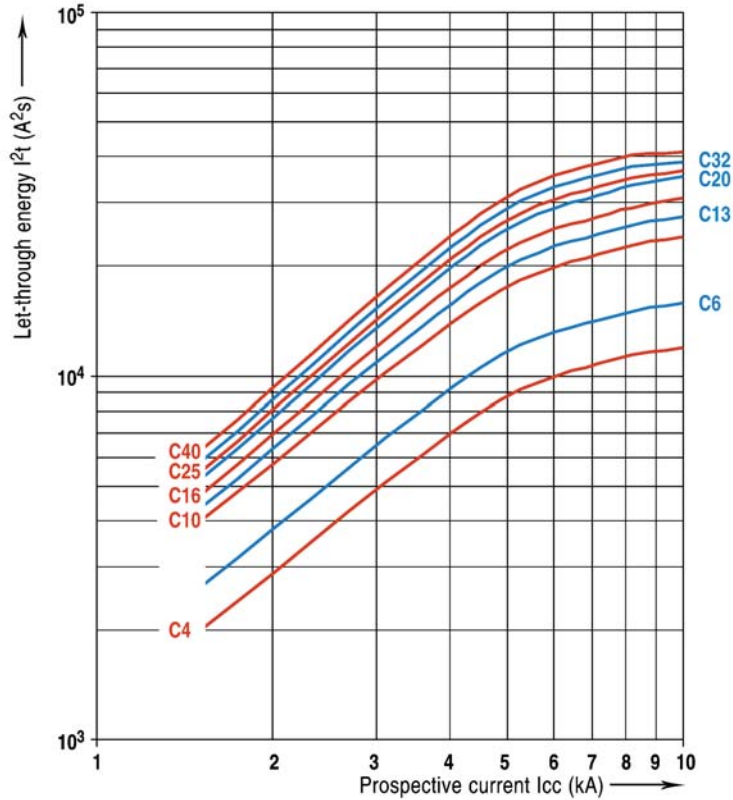

RCBO - Din-Safe (DSRCB)

RCBO - Din-Safe (DSRCB)

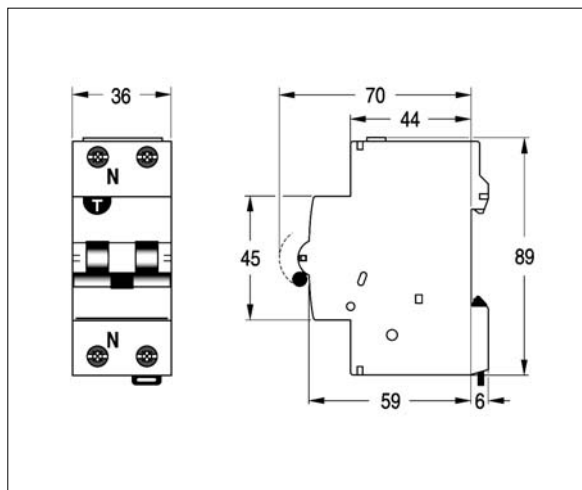

Dimensions in mm

Din-T MCBs + RCDs Technical data

Text for specifiers

RCBO DinSafe (DSRCB)

- The residual making and associated MCB:
 - ☛ Din-T66000 A
 - ☛ Din-T107500 A
- According to EN 61009 standard.
- Intended to detect residual sinusoidal currents (type AC) or residual pulsating direct currents (type A).
- Resistance against nuisance tripping according to VDE 0664 T1 and EN 61009.
- Working ambient temperature from -25 °C up to +40 °C for type A and from -5 °C up to +40 °C for type AC.
Approved by CEBC, VDE , KEMA, IMQ, etc.
- The RCBO 1 P+N is 2 modules wide or 1 module wide.
- The neutral pole is on the left hand side. The N pole closes first of all poles and opens last of all poles.
- Nominal rated currents are: 4 up to 40 A.
- Characteristic B & C.
- Nominal residual currents are: 10, 30, 100, 300, 500, 1000 mA.
- The test circuit is protected against overloads.
- The short-circuit capacity is 10 kA, with selectivity class 3.
- The making and breaking capacity is 500 A.
- The residual making and breaking capacity is 7500 A.
- Terminal capacity from 1 up to 25 mm² rigid in the top terminals and from 1 up to 35 mm² in the bottom terminals.
- The devices 10, 30, 100 mA type A or AC always have vertical selectivity with devices 300 mA type S.
- Both incoming and outgoing terminals have a protection degree of IP 20.
- Isolator function due to Red/Green printing on the toggle.
- Auxiliary contacts can be added on the right hand side.
- RCBOs can be released by means of a shunt trip or undervoltage release.
- RCBOs can be remotely controlled by means of a motor operator.

Din-T MCBs + RCDs Technical data

Overview Din-Safe RCDs

RCBO



Device type definition

Rating/description	Cat. No.	DSRCB	
Standards		IEC 61009-1	
Magnetic tripping characteristics		C	
Residual tripping characteristic ¹⁾		AC, A	
Tripping time at I Δ n	Instantaneous	ms	<300
	Selective	ms	-
Rated current	A	4, 6, 10, 13, 16, 20, 25, 32, 40	
Rated residual current I Δ n	mA	10, 30	
Calibration temperature	°C	30	
Number of poles versus modules		1	
Rated voltage Un	2 P AC	V	110, 240 (1 P+N)
	3 P AC	V	-
	4 P AC	V	-
Frequency	Hz	50/60	
Maximum service voltage U _{bmax}	V	255	
Minimum service voltage U _{bmin}	V	100	
Power supply		Top/Bottom	
Selectivity class		3	
Rated making and breaking capacity (I _m)	A	-	
Residual making and breaking capacity (I Δ m)	A	7500	
Conditional short-circuit capacity (I _{nc})	A	-	
Conditional residual short-circuit capacity (I Δ c)	A	-	
Short-circuit capacity (I _{cn})	A	10000	
Grid distance (safety distance between two devices)	mm	35	
Isolator application		yes	
Insulation degree	Insulation voltage	V (DC)	500
	Shock voltage (1.2/50 ms)	kV	6
	Insulation resistance	(mOhm)	1000
	Dielectric strength	V	2500
Shock resistance (in x, y, z direction)(IEC 60077/16.3)		40 g, 18 shocks 5 ms	
Vibration resistance (in x, y, z direction; IEC 60068-2-6)		1.5 g, 30 min, 0...80 Hz	
Endurance	electrical at Un, In		10000
	mechanical at Un, In		20000
Protection degree (outside/inside electrical enclosure)		IP 20 / IP 40	
Self extinguish degree (according to UL 94)		V2	
Tropicalisation (according to IEC 60068-2, DIN 40046)	°C/RH	+55/95 %	
Pollution degree (acc. IEC 60947-1)		3	
Operating temperature	°C	-25...+60	
Storage temperature	°C	-5...+70	
Terminals capacity	Rigid cable min/max (Top)	mm ²	1/25
	Flexible cable min*/max (Top)	mm ²	1/16
	Rigid cable min/max (bottom)	mm ²	1/35
	Flexible cable min*/max (bottom)	mm ²	1/25
	(*Flexible cable 0.75/1/1.5 mm ² with cable lug)		
Torque	Top/Bottom	Nm	3/4
Add-on devices (side add-on)	Auxiliary contacts		yes
	UVT		yes
	Shunt trip		yes
	Motor operator		yes
	Panelboard switch		Bottom
Busbars systems	Pin		Bottom
	Fork		yes
Accessories			
Dimensions, weights, packaging	# Poles		1+N
	(HxDxW) 86x68xW	mm	36
	Weight/unit	g	250
	Package/unit		1/6

Note: ¹⁾ Refer catalogue section for types.

²⁾ Making sure that N-L and both flying leads are disconnected.